

# Student Book Answer Key

## Unit 01 My Classroom

pp.06~07



p.09

**Practice** Stick and say.



p.11

**Practice** Look and match. Then say.

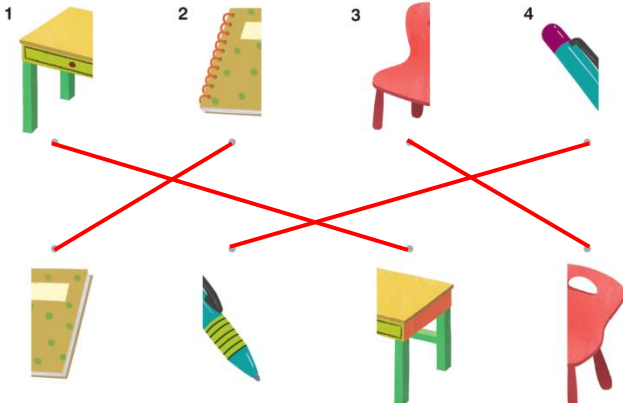

p.12

**Read & Understand** Read and match.

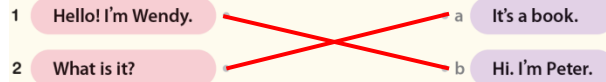

p.13

**Phonics** Trace. Then listen and repeat.



**Read & Do** Connect the dots. Then say.

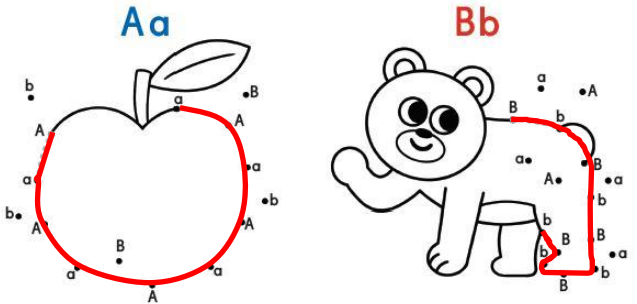

## Unit 02 Colors

pp.14~15



p.17

**Practice** Stick and say.



p.19

**Practice** Look and color the other half.

Then say.



p.20

**Read & Understand** Read and match.

- 1 How are you?  a I'm fine.
- 2 What color is it?  b It's red.

p.21

**Phonics** Trace. Then listen and repeat.



**Read & Do** Color and say.

Cc → | Dd →

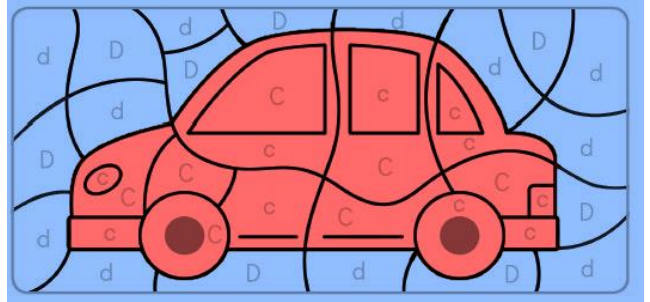

## Unit 03 Numbers

pp.24~25





p.27

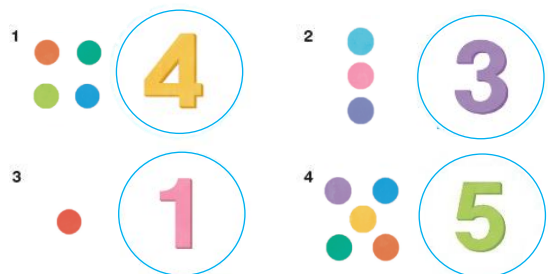

**Practice** Stick and say.



p.29

**Practice** Count and circle. Then say.

1  2 

3  4 

p.30

**Read & Understand** Read and match.

1 How old are you? a Seven.

2 How many? b I'm ten.

p.31

**Phonics** Trace. Then listen and repeat.



**Read & Do** Find the way out. Then say.

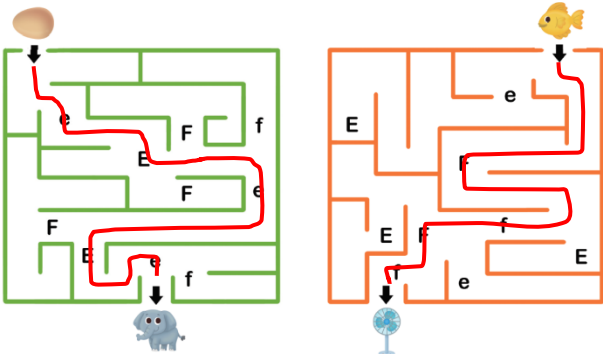

## Unit 04 Shapes

pp.32~33

**Unit 04 Shapes**  
Lesson 1

**Song** Watch. Then listen and sing.  



I'm sorry. I'm sorry.  
That's OK. That's OK.  
I'm sorry.  
That's OK.

**Story** Listen.  

**Puzzle**  Look & Find 

p.35

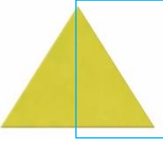

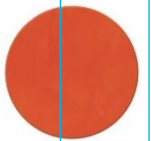

**Practice** Stick and say.

1  2 





3  4 

p.37

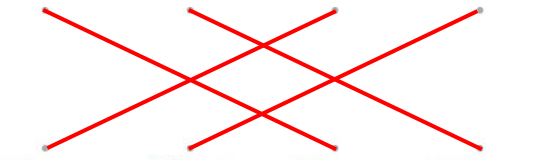
**Practice** Look and match. Then say.

1  2  3  4 



p.38

**Read & Understand** Read and match.

1	What shape is it?		a	That's OK.
2	I'm sorry.		b	It's a diamond.

p.39

**Phonics Review** Look and stick. Then say.

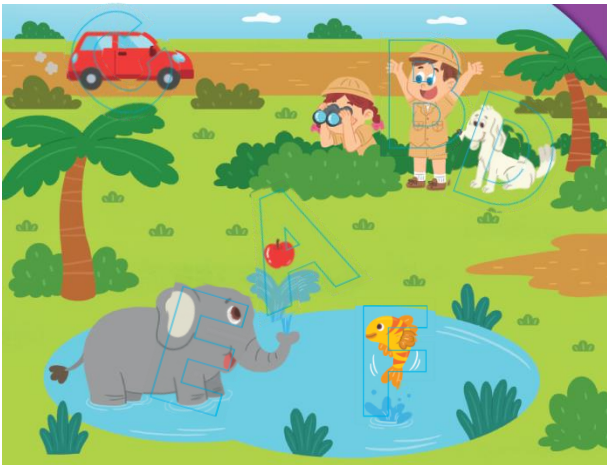

## Unit 05 My Family

pp.42~43

Unit **05** My Family  
Lesson 1

**Song** Watch. Then listen and sing.

Thank you.  
You're welcome.  
Thank you.  
Thank you.  
You're welcome.  
You're welcome.

**Story** Listen.

**Puzzle** Look & Find

p.45

**Practice** Stick and say.

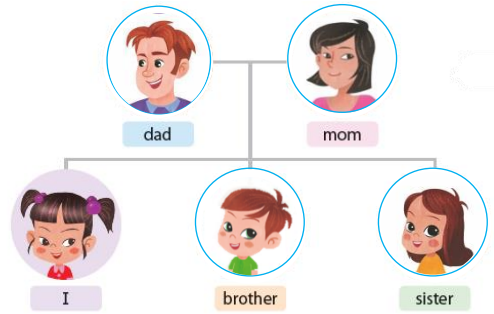

p.47

**Practice** Look and match. Then say.

1		2		3		4	

p.45

**Read & Understand** Read and match.

1	Who is this?		a	This is my dad.
2	Thank you.		b	You're welcome.

p.46

**Phonics** Trace. Then listen and repeat.



**Read & Do** Color and say.

Gg →  | Hh → 

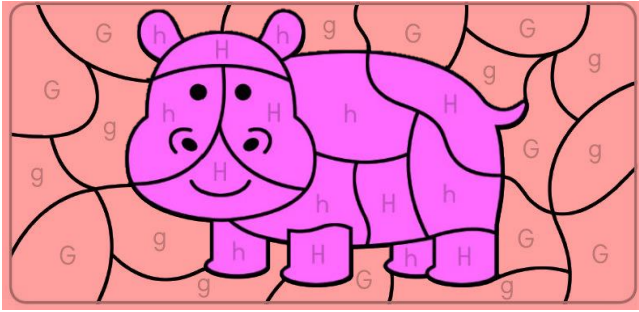

## Unit 06 Toys

pp.50~51



p.53

**Practice** Stick and say.

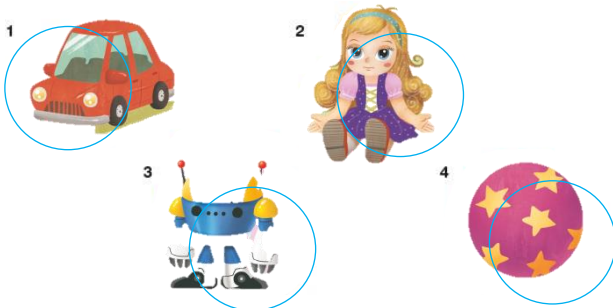

p.55

**Practice** Look and match. Then say.

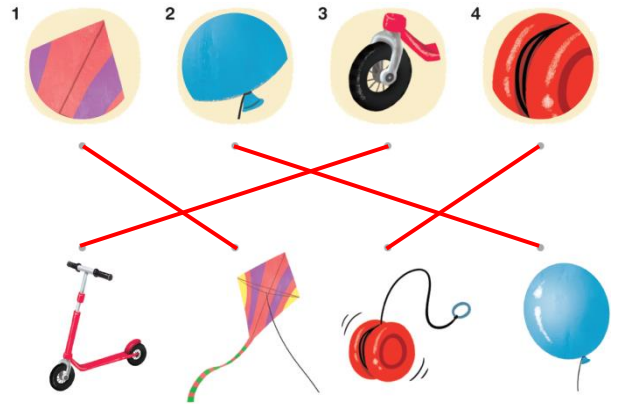

p.56

**Read & Understand** Read and match.

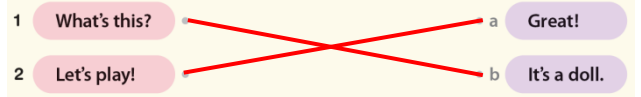

p.57

**Phonics** Trace. Then listen and repeat.



**Read & Do** Connect the dots. Then say.

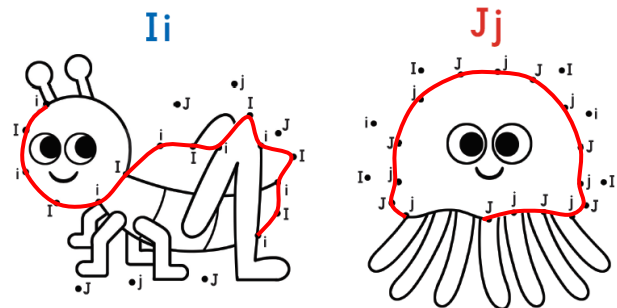



p.71

**Practice** Stick and say.



p.73

**Practice** Look and match. Then say.

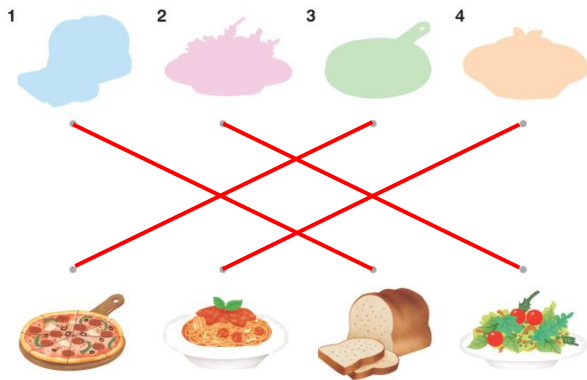

p.74

**Read & Understand** Read and match.

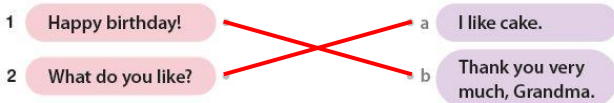

p.75

**Phonics Review** Look and stick. Then say.

